

June 2020

BEHAVIOR OF REINFORCED CONCRETE BEAMS CONTAINING LIGHTWEIGHT AGGREGATE IN THE TENSILE ZONE

Jamal Khatib

Professor, Faculty of Engineering, Beirut Arab University, Beirut, Lebanon, j.khatib@bau.edu.lb

Ali Jahami

PhD, Faculty of Engineering, Beirut Arab University, Beirut,, a.jahmi@bau.edu.lb

Oussama Baalbaki

Professor, Faculty of Engineering, Beirut Arab University, Beirut, Lebanon, obaalbaki@bau.edu.lb

Adel Elkordi

Professor, Faculty of Engineering, Beirut Arab University, Beirut, Lebanon, a.elkordi@bau.edu.lb

Hakim Abdelgader

Professor, Department of Civil Engineering, University of Tripoli, Tripoli, Libya; Faculty of Civil and Environmental Engineering, Gdansk University, Gdansk, Poland, h.abdelgader@uot.edu.ly

Follow this and additional works at: <https://digitalcommons.bau.edu.lb/stjournal>



Part of the [Architecture Commons](#), [Business Commons](#), [Engineering Commons](#), and the [Physical Sciences and Mathematics Commons](#)

Recommended Citation

Khatib, Jamal; Jahami, Ali; Baalbaki, Oussama; Elkordi, Adel; and Abdelgader, Hakim (2020) "BEHAVIOR OF REINFORCED CONCRETE BEAMS CONTAINING LIGHTWEIGHT AGGREGATE IN THE TENSILE ZONE," *BAU Journal - Science and Technology*. Vol. 1 : Iss. 2 , Article 3.

Available at: <https://digitalcommons.bau.edu.lb/stjournal/vol1/iss2/3>

This Article is brought to you for free and open access by Digital Commons @ BAU. It has been accepted for inclusion in BAU Journal - Science and Technology by an authorized editor of Digital Commons @ BAU. For more information, please contact ibtihal@bau.edu.lb.

BEHAVIOR OF REINFORCED CONCRETE BEAMS CONTAINING LIGHTWEIGHT AGGREGATE IN THE TENSILE ZONE

Abstract

In reinforced concrete design, the concrete in the tensile zone is assumed to be ineffective and increase the dead load of the structural elements. In order to reduce the self-weight, this paper examines the structural behavior of reinforced concrete beams containing lightweight concrete in the tensile region and normal weight concrete in the rest of the beam. The lightweight concrete was made from waste polystyrene. Four reinforced concrete beams were prepared with different depth of lightweight concrete. The control beam B1 consists of normal concrete. In Beams B2, B3 and B4, the depth of lightweight concrete was 25%, 50% and 75% of the total depth of the beam measured from the bottom surface respectively. A four-point bending test was conducted on all beams. The beams were loaded in increments until failure. At each load increment, the central deflection was determined. Cracks initiation and the mode of failure were observed during the experiment. The failure load was found to decrease with the increase of depth of lightweight concrete. The presence of lightweight aggregate tends to cause brittle failure. In addition, the mode of failure for reinforced concrete beams containing lightweight concrete was a shear failure.

Keywords

Cracks, Deflection, Lightweight concrete, Reinforced concrete beam, Waste polystyrene

1. INTRODUCTION

Using waste material in construction applications is likely to contribute towards sustainable development. waste materials include municipal solid waste incineration ash (Khatib *et al.* 2019^a, Charbaji *et al.* 2018^a, Charbaji *et al.* 2018^b, Machaka *et al.* 2019, Baalbaki *et al.* 2019). The incorporation of lightweight aggregate in concrete is beneficial, as it would lead to reduction the self-weight, thus leading to lower ratio of reinforcement and material saving (Saad *et al.* 2019).

Minapu *et al.* (2014) has examined the partial replacement of natural coarse aggregate with lightweight aggregate in concrete. The lightweight aggregate used was pumice stone. The strength properties (compressive, tensile and flexural) of concrete made with pumice stone was not dissimilar to that made with natural aggregate.

Tang Van *et al.* (2018) studied the effect of using expanded polystyrene aggregate (EPS) and bottom ash (BA) as partial replacement of coarse aggregate and fine aggregates on concrete properties. The BA and EPS contents ranged from 0-30% and 0-40% respectively. Generally, there is a systematic decrease in compressive strength with the increase of either BA or EPS. Concrete containing 40% EPS and 30% BA replacement caused a reduction of 25% compared with the control mix.

Kumar & Prakash (2015) used cinder and Leca aggregates to produce structural lightweight concrete. The coarse aggregate replacement ranged from 0 to 50% by volume. It was found that replacing 60% Cinder and 40% Leca aggregate produced a lightweight concrete with a compressive strength of about 29 N/mm² and a splitting tensile strength of 1.67 N/mm². Replacing 20% of cement with Ground Granulated Blast Furnace Slag (GGBFS) was found to increase the concrete compressive strength to 30.7 N/mm².

The present investigation attempts to study the structural behavior of reinforced concrete beams on layer of lightweight concrete in the tensile region and normal concrete in the rest of the beams. Future research will investigate the behavior of reinforced concrete beams and slabs using both lightweight and normal weight concrete subjected to impact (Jahami *et al.* 2018, Jahami *et al.* 2019, Jahami *et al.* 2020, Khatib *et al.* 2019^a, Khatib *et al.* 2019^b)

2. EXPERIMENTAL WORK

2.1 Mix design

Two mixes were prepared for this investigation. The first mix had a proportion of 1 (cement): 2 (fine aggregate): 4 (coarse aggregate) by weight. In the second mix, the waste polystyrene aggregate (WPA) replaced all the coarse aggregate (by volume). The maximum coarse aggregate and fine aggregate size were 20mm and 5mm respectively. The cement used was CEM1. The waste polystyrene was obtained from old packaging as shown in Figure 1 and crushed to produce lightweight coarse aggregate. The density of polystyrene was found to be 0.96 g/cm³. The water to cement (W/C) ratio for all concrete mixes was 0.6. This high W/C ratio was adopted to avoid using any chemical admixture. These proportions of materials were chosen based on several trials to achieve a workable mix without the use of superplasticizer. Table 1 presents further details of the concrete mixes.

Table 1: Details of concrete mixes

| Mix | Mix Code | Quantities per cubic meter (Kg/m ³) | | | | |
|-------|----------|---|-------|------|--------|-----------------------------------|
| | | Cement | Water | Sand | Gravel | Waste Polystyrene Aggregate (WPA) |
| Mix 1 | NWC | 450 | 225 | 743 | 1543 | 0.0 |
| Mix 2 | LWC | 450 | 225 | 743 | 0 | 14.3 |



Fig.1: Crushed waste polystyrene particles (5mm diameter)

2.2 Reinforced Concrete Beam Details

The beams had overall dimensions of 200mm x 300mm x 1500mm. Figure 2 shows the beam dimensions and reinforcement details. Four beams were cast in this study based on ASTM C31 standards. The first beam (B1) was cast using normal weight aggregate only. In the other 3 beams, lightweight concrete (LWC) was first cast and the depth of the LWC was 25%, 50% and 75% of the total depth for beams B2, B3, and B4 respectively. All beams had the same flexural and shear reinforcement: 3T10mm as bottom steel, 2T8mm as top steel, and T6mm@50mm as shear reinforcement (links). The spacing between links was chosen so that the beams tend to fail in shear. Details of the depth of the normal and lightweight concrete in the four beams are shown in Figure 3.

After calculating the quantity of materials (i.e. cement, aggregate, sand, and water) per mix, the materials were weighed. Timber molds were used to cast the concrete specimens (i.e. cubes and beams). The molds were cleaned and oiled before casting. For the compressive strength test, cubes of dimensions 100mm x 100mm x 100mm were used. For the Modulus of Elasticity (E) cylinders with a diameter of 100mm and a length of 200mm were cast. For the structural performance, beams of 200mm x 300mm x 1200mm were used. The dry materials were introduced to the mixer in the following sequence; coarse aggregates, fine aggregate and cement. They were initially mixed for two minutes, then water was added slowly and mixing continued until a homogenous mix was obtained. Before casting, the slump for each mix was measured.

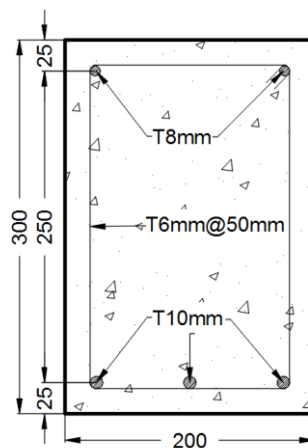

Fig.2: Beams details

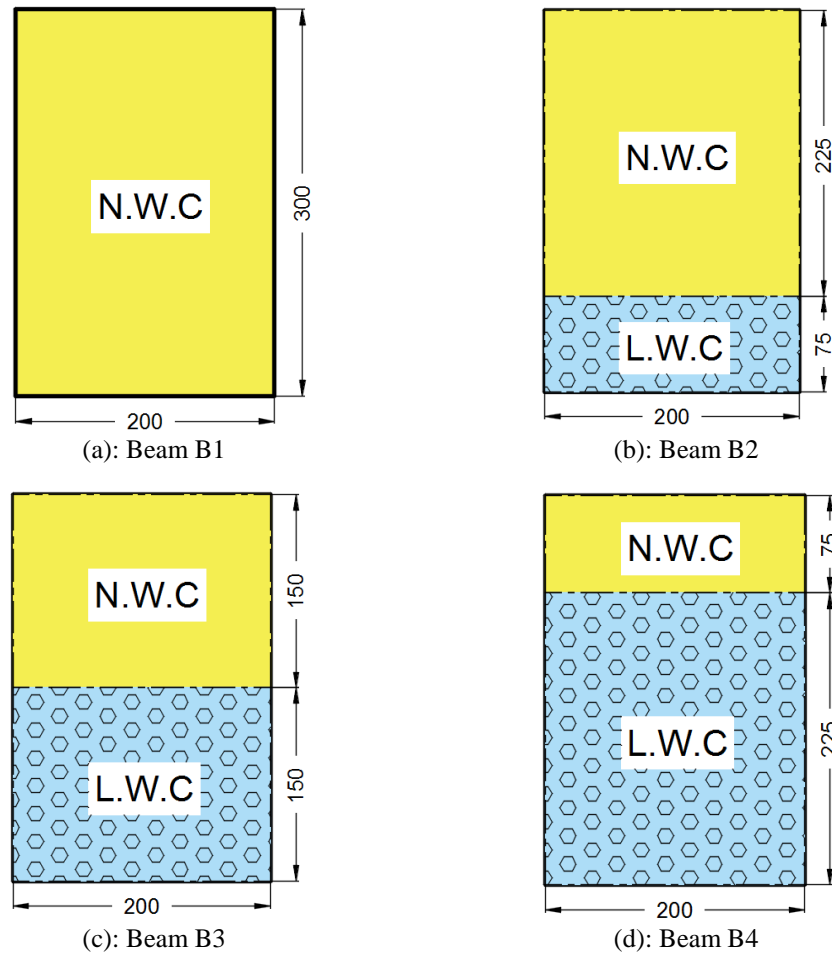

Fig.3: Depth of lightweight concrete in the beams (mm)

The casting of cubes was carried out in two layers. Each layer is compacted in order to remove entrapped air. The slump test was determined and was found to be 12 mm and 15 mm for NWC and LWC respectively. For each mix, 9 cubes, 3 cylinders, and 4 beams were cast. After casting, the cubes and cylinders were placed in a water tank, while the beams are covered with wet burlap and remained in the lab until testing.

2.3 Testing

The compressive strength and the modulus of elasticity tests were conducted according to (BS EN 12350-1:2000) and (BS EN 12390-13:2013) respectively. The four-point bending was used to assess the behavior of the reinforced concrete beams as shown in Figure 4. The beam was tested at 5kN increment until yielding started and the central deflection measured. The load at first crack was recorded. The loading continued until failure. The propagation of cracks was observed throughout the duration of the test.

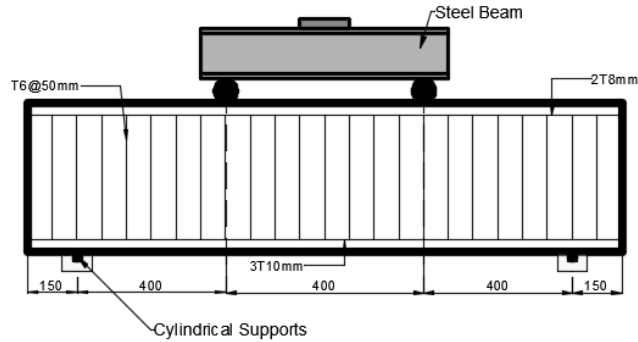

Fig.4: Longitudinal section of the beam with supports and loads (dimensions in mm)

3. RESULTS AND DISCUSSION

The density of the normal and lightweight concrete mix is shown in Figure 5. The density of NWC and LWC was 2416 and 1188 kg/m³ respectively, indicating a reduction of 50% when LWC is used compared with NWC. The compressive strength and modulus of elasticity for the NWC and LWC are respectively shown in Figures 6 and 7 respectively for concrete cured for 1, 7, and 28 days. Using light weight aggregate caused a drastic reduction in both compressive strength and modulus of elasticity. A reduction of 88% and 77% is obtained at the age of 28 days of curing for compressive strength and modulus of elasticity respectively.

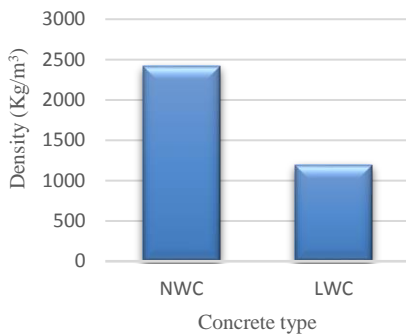

Fig.5: Density for NWC and LWC

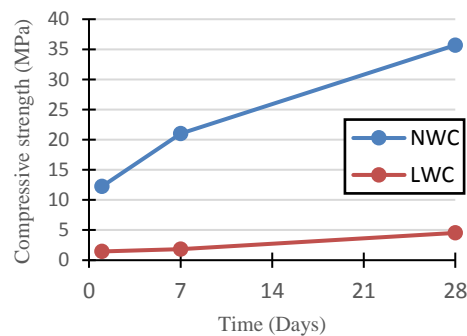

Fig.6: Compressive Strength for NWC and LWC

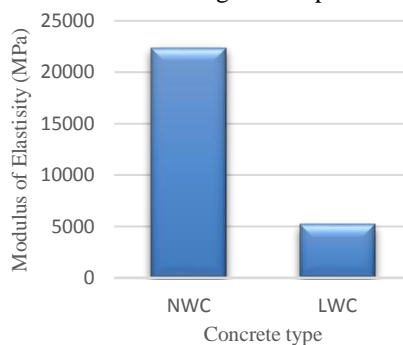

Fig.7: Modulus of Elasticity for NWC and LWC

The load-deflection curves for all reinforced concrete beams are plotted in Figure 8. The failure load for beams with LWC was lower than the beam with NWC. In addition, beams with lightweight concrete failed in brittle mode. This is due to the large difference in both compressive strength and modulus of elasticity between NWC and LWC. The maximum load capacity (P_{max}) for beams B1, B2, B3, and B4 was 370KN, 122KN, 110KN, and 109KN respectively. This indicates that the failure load for the control beam is more than 3 times that of the other beams. The difference in the failure load for the beams with LWC is negligible. Based on the ACI code formula, the shear stress “τ” can be determined using Equation 1 as follows:

$$\text{Eq.(1)} \quad \tau = (P_{\max} / 2) / (b.d)$$

Where “ τ ” is in MPa, “ P_{max} ” is in N, “ b ” and “ d ” are the width (200 mm) and the effective depth (270 mm) of the beam. Based on Equation 1 the shear stress capacity for each beam is illustrated in Table 2.

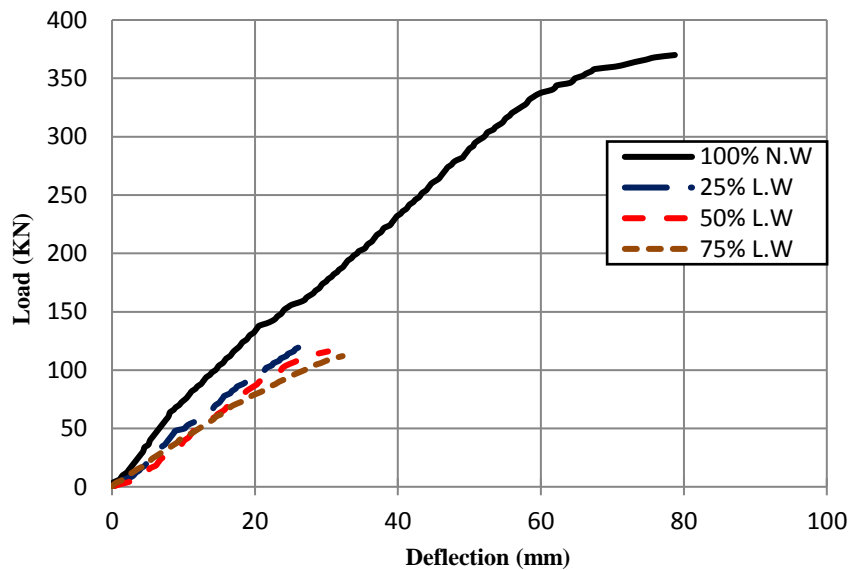

Fig.8: Load-Deflection curve for all beams

Table 2: Shear stress capacity for each beam

| Beam | LWC* | P_{max} (kN) | τ (MPa) |
|------|------|----------------|--------------|
| B1 | 0 | 370 | 3.36 |
| B2 | 25 | 122 | 1.1 |
| B3 | 50 | 110 | 1 |
| B4 | 75 | 109 | 0.99 |

*Percentage of total depth measured from the bottom of the beam.

Figures 9 to 12 show the damage pattern for all beams. All beams failed in shear indicated by the diagonal cracks. This can be realized from the inclined crack patterns that were extended from the bottom supports until the top of the beam near the points of the applied load. Wider cracks were observed for beams (B3) and (B4) especially near the supports. There were clear cracks between the end supports and the point of application of the load.



Fig.9: Beam (B1) at failure



Fig.10: Beam (B2) at failure



Fig.11: Beam (B3) at failure



Fig.12: Beam (B4) at failure

4. CONCLUSIONS

The following conclusions are based on the results of the current investigation:

- 1) The failure load in reinforced concrete beams tends to drastically decrease when part of the beam contains lightweight concrete.
- 2) The beams containing LWC had a small shear capacity compared to the beam with NWC. This reduction was about 70% for beam (B4) containing lightweight concrete only compared to the control beam (B1).
- 3) Using lightweight concrete portions in reinforced concrete beams tends to exhibit a brittle behavior.

REFERENCES

- ACI, A. (2014). 318-14. *Building Code Requirements for Structural Concrete*, American Concrete Institute, Farmington Hills, Michigan.
- Anil Kumar, R., & Prakash, P. (2015). Studies on structural light weight concrete by blending light weight aggregates. *International Journal of Innovative Research in Engineering & Management*, 2(4), 48-52.
- ASTM C31 / C31M-19a, Standard Practice for Making and Curing Concrete Test Specimens in the Field, ASTM International, West Conshohocken, PA, 2019, Retrieved from www.astm.org

- Baalbaki, O., Elkordi, A., Ghanem, H., Machaka, M., & Khatib, J. M. (2019). Properties of concrete made of fine aggregates partially replaced by incinerated municipal solid waste bottom ash. *Academic Journal of Civil Engineering*, 37(2), 532-538.
- BS EN 12350-1:2000 - Testing fresh concrete. (2000). *Sampling*. London: British Standards Institution.
- BS EN 12390-13:2013 Testing hardened concrete (2013). *Determination of secant modulus of elasticity in compression*. London: British Standards Institution.
- Charbaji, M., Baalbaki, O., Elkordi, A., Khatib, J. (2018a). Processing Of Incinerated Municipal Solid Waste Fly Ash For Use In Concrete. *International Journal of Civil Engineering and Technology (IJCIET)*, 1853-1864.
- Charbaji, M., Baalbaki, O., Khatib, J. M., Elkordi, A. (2018b). Characterization of Fly Ash Originated From Lebanese Municipal Solid Waste Plant. *International Congress on Engineering and Architecture, Turkey*, 1565-1576.
- Jahami, A., Khatib, J., & Firat, S. (2019b). Load deflection characteristics of reinforced concrete beams incorporating fibers made of waste plastic straw. In *2nd International Turkish World Engineering and Science Congress* (pp. 326-332). Antalya.
- Jahami, A., Khatib, J., Baalbaki, O. & Sonebi, M. (2019a). Prediction of deflection in reinforced concrete beams containing plastic waste. *3rd International Conference on Bio-Based Building Materials*, pp. 551-555. Belfast, UK.
- Jahami, A., Temsah, Y., Khatib, J., & Sonebi, M. (2018). Numerical study for the effect of carbon fiber reinforced polymers (CFRP) sheets on structural behavior of posttensioned slab subjected to impact loading. In *Proceedings of the Symposium on Concrete Modelling-CONMOD2018, RILEM PRO* (Vol. 127, pp. 259-267).
- Khatib, J., Herki, B., Elkordi, A. (2019a). Characteristics of concrete containing EPS, *Use of Recycled Plastics in Eco-efficient Concrete*, Woodhead Publishing.
- Khatib, J., Jahami, A. & Baalbaki, O. (2019b). Flexural characteristics of reinforced concrete beams containing lightweight aggregate in the tensile zone. *Fifth International Conference on Sustainable Construction Materials and Technologies*, Kingston University, London, UK.
- Khatib, J., Jahami, A., Elkordi, A., Baalbaki, O. (2019c). Structural performance of reinforced concrete beams containing plastic waste caps. *Magazine of Civil Engineering*, 91(7), 73–79.
- Machaka, M., Khatib, J., Elkordi, A., Ghanem, H., Baalbaki, O. (2019). Selected properties of concrete containing Municipal Solid Waste Incineration Bottom Ash (MSWI-BA). In *5th International Conference on Sustainable Construction Materials and Technologies (SCMT5)*, Kingston University London (in Partnership with Coventry University), UK, 14 – 17.
- Minapu, L. K., Ratnam, M. K. M. V., & Rangaraju, U. (2014). Experimental study on Light Weight Aggregate Concrete with Pumice stone, silica fume and fly ash as a partial replacement of coarse aggregate. *International Journal of Innovative Research in Science, Engineering and Technology*, 3(12), 18130-18138.
- Saad, M., Baalbaki, O., Khatib, J., Elkordi, A., Masri, A. (2019). Manufacturing of Lightweight Aggregates from Municipal Solid Waste Incineration Bottom Ash and their Impacts on Concrete Properties. In *2nd International Congress on Engineering and Architecture*, Pages 1638 – 1649. Marmaris, Turkey.
- Van, L. T., Dinh, T. V., Kim, D. V., Bulgakov, B., Aleksandrova, O., & Bazhenova, S. (2018). Combined Effects of Bottom Ash and Expanded Polystyrene on Light-weight Concrete Properties. In *MATEC Web of Conferences* (Vol. 251, p. 01007). EDP Sciences.